

Thank you for purchasing the Performance Tackboard for PL 116.  
Please follow these instructions for easy assembly.

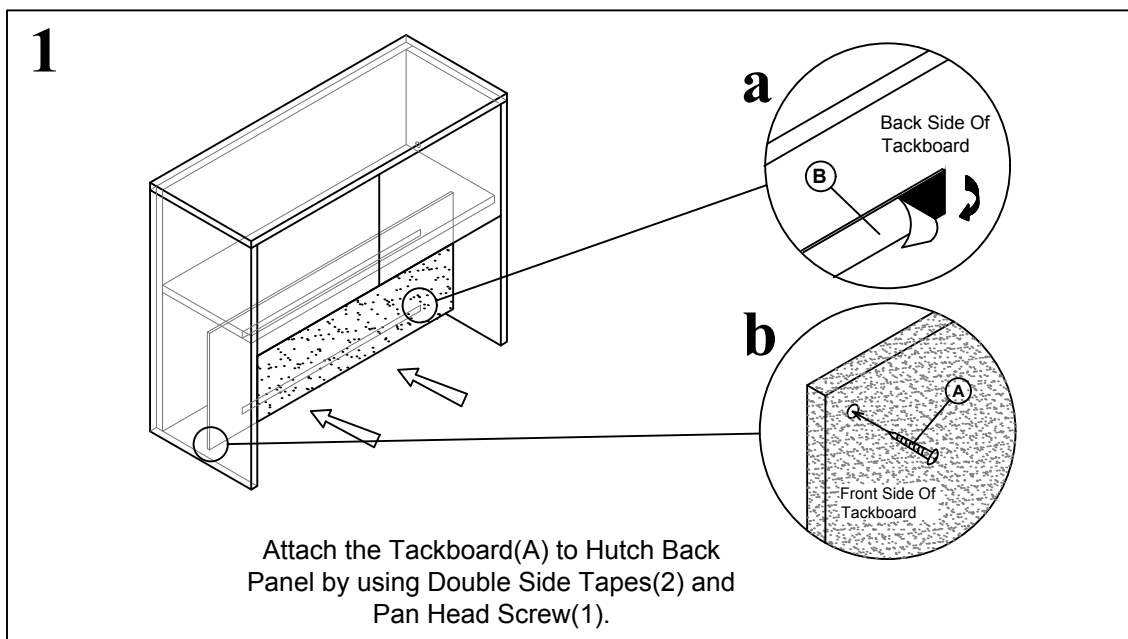
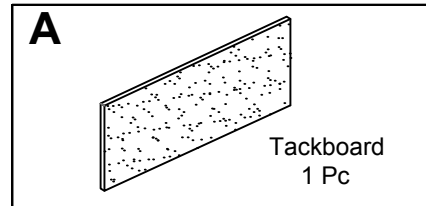
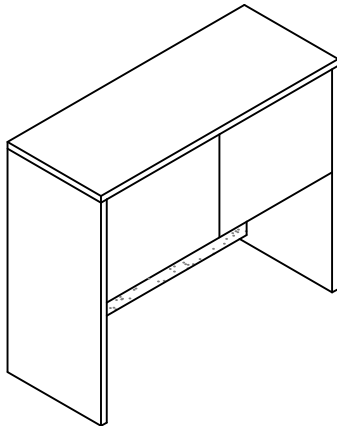
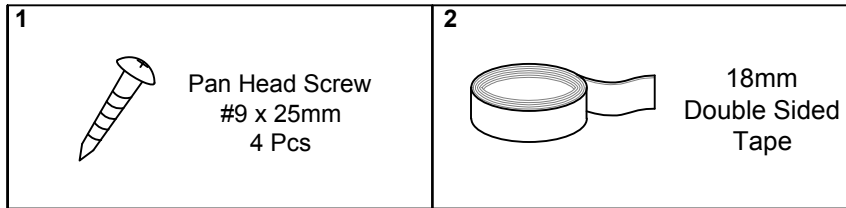

**IMPORTANT !!**

- Place all wooden parts on a clean and smooth surface such as a rug or carpet to avoid the parts from being scratched.
- Check that you have all parts and hardware.
- Remove all wrapping materials, including staples & packing straps before you start to assemble.
- Do not tighten any screws or bolts until the unit is completely assembled.
- Keep all hardware parts out of reach of children.